

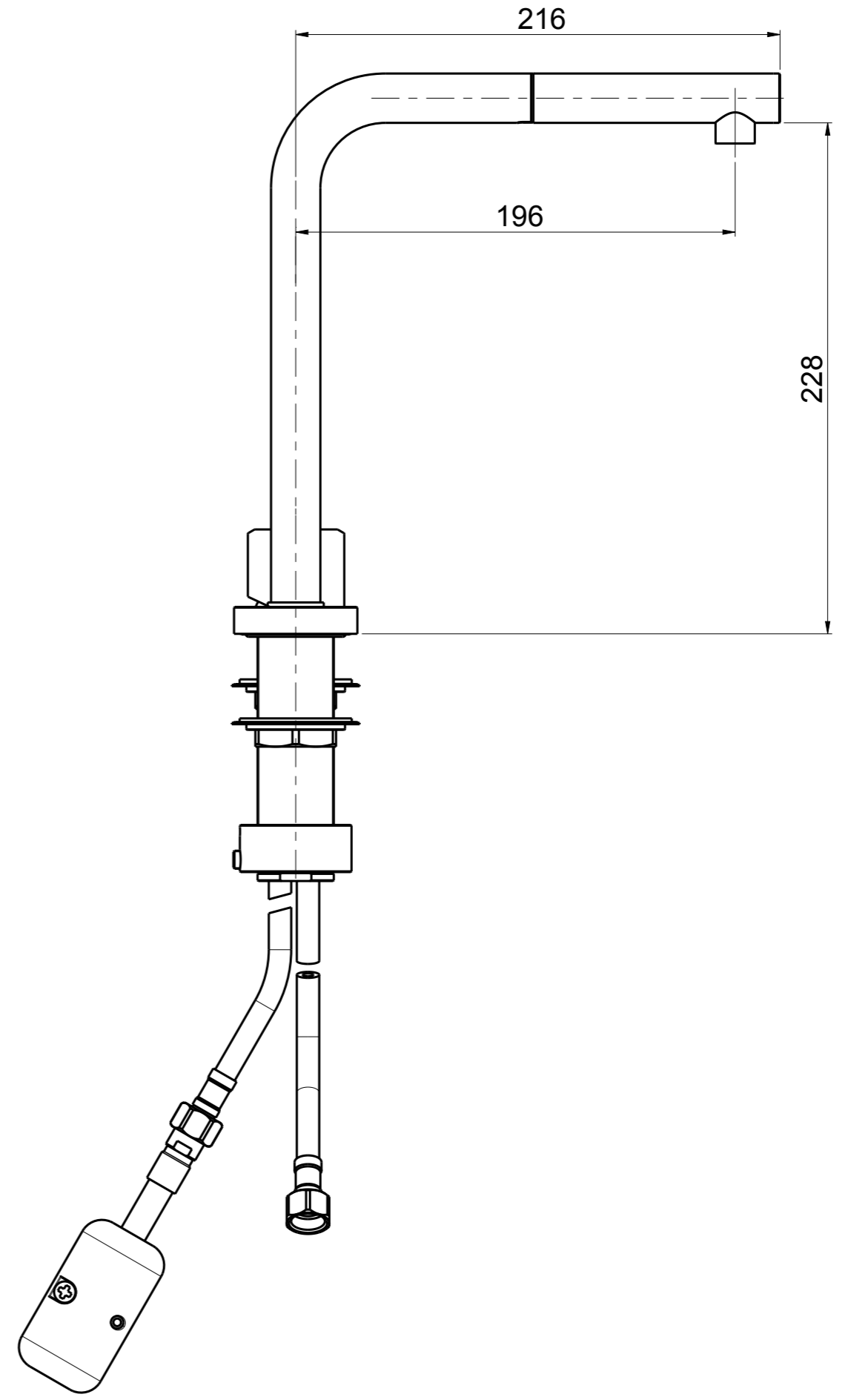

Questo disegno e' di proprieta' Quadro. s.r.l. che, a norma di legge, si riserva tutti i diritti.

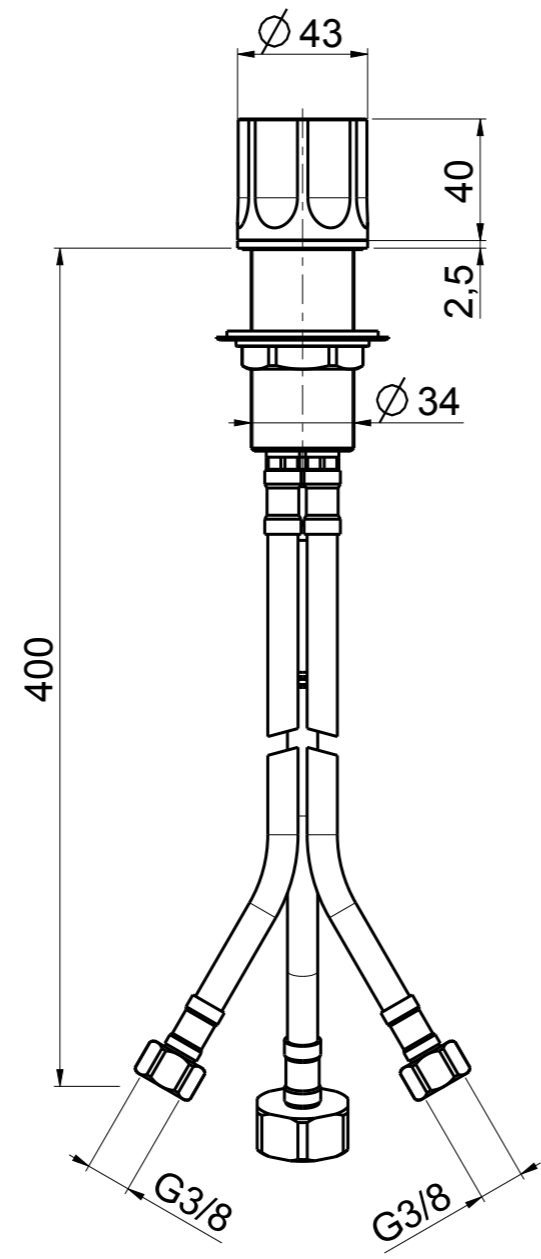
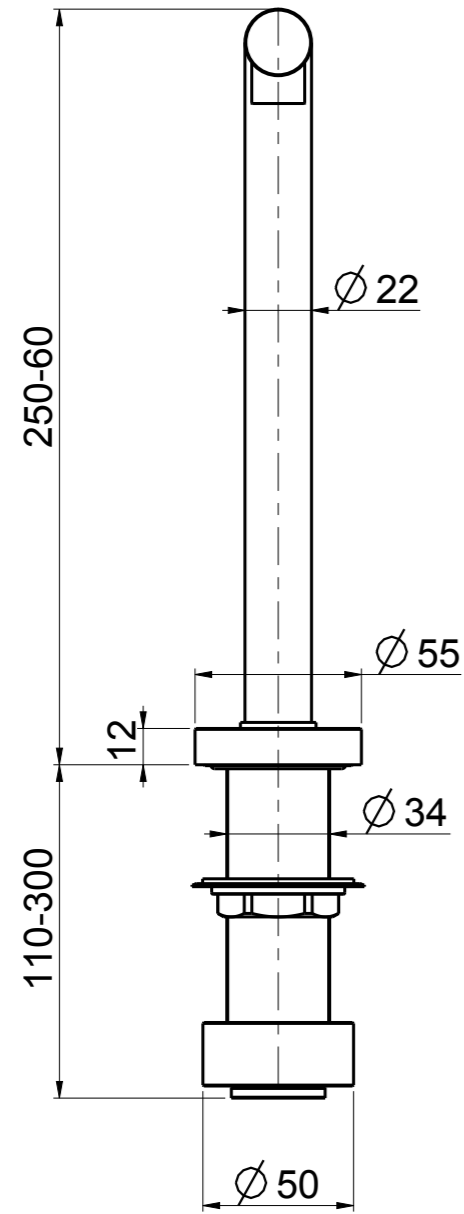
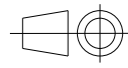

 Tel. 0322 96266 Fax 0322 967264 e-mail: info@quadrodesign.it Via Bonetto, 40 28017 San Maurizio d'Opaglio (No) ITALY	DATA	07/03/2023	VERSIONE	PROGETTO	SCALA	NOTE	
	DISEGNATORE	D. N.	1.4		2:5		
	DESCRIZIONE						
LAVELLO COMANDO SEPARATO TELESCOPICO						443-17	